

DUŞAKABİN PİLOT KAPI

**1494 - 0,237 Kg/m****1493 - 0,297 Kg/m****1491 - 0,401 Kg/m****1492 - 0,282 Kg/m****1490 - 0,416 Kg/m****1958 - 0,305 Kg/m****550 cm - 600 cm****1879 - 0,569 Kg/m****600 cm****1959 - 0,455 Kg/m****550 cm - 600 cm**

DUŞAKABİN

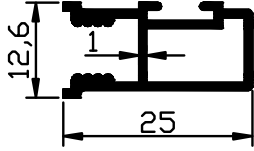
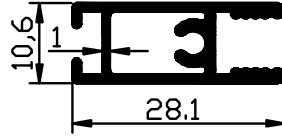
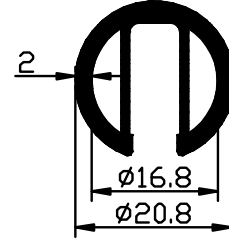
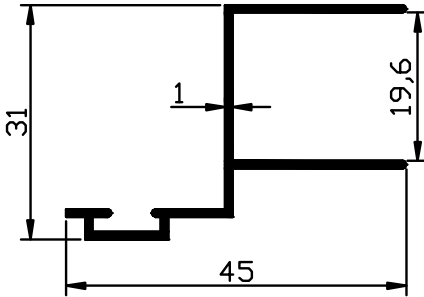
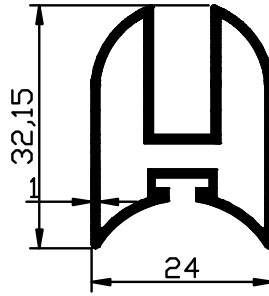
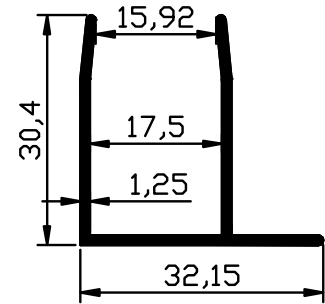
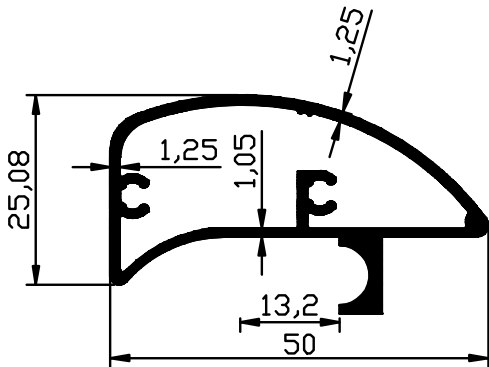
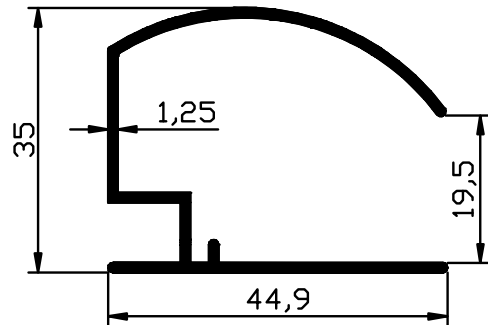
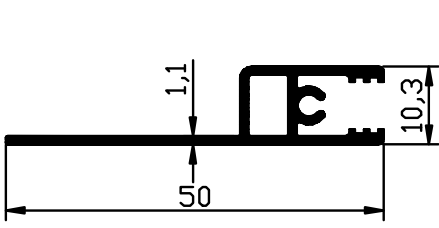

1556 - 0,289 Kg/m

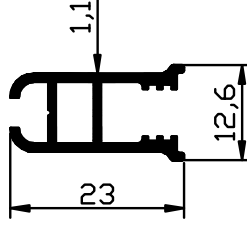

1560 - 0.205 Kg/m

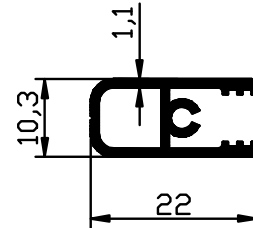

1559 - 0.209 Kg/m

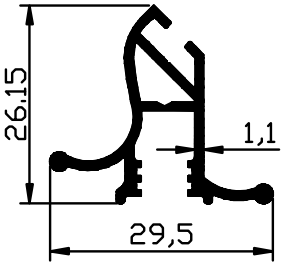

1561 - 0,286 Kg/m

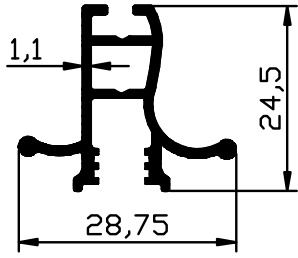

1562 - 0,286 Kg/m

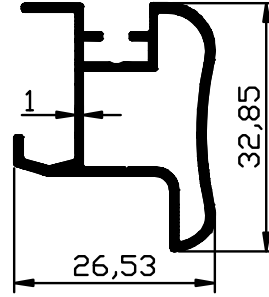

2088 - 0,363 Kg/m

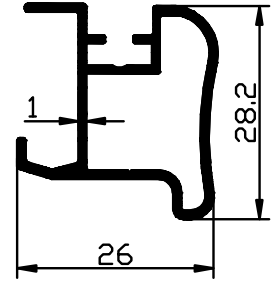

1555 - 0,335 Kg/m

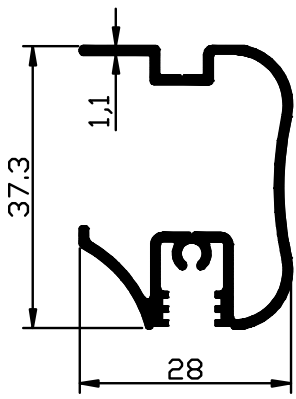

1554 - 0,400 Kg/m

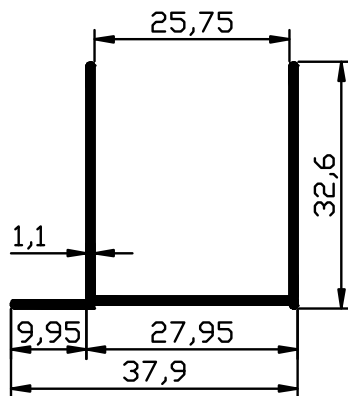

2089 - 0,300 Kg/m

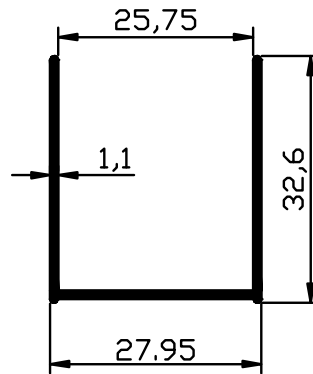

1558 - 0,270 Kg/m

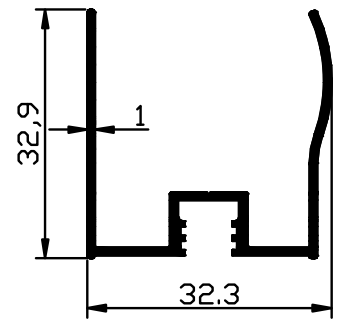

1557 - 0,313 Kg/m

DUŞAKABİN SÜPER LÜKS SERİSİ

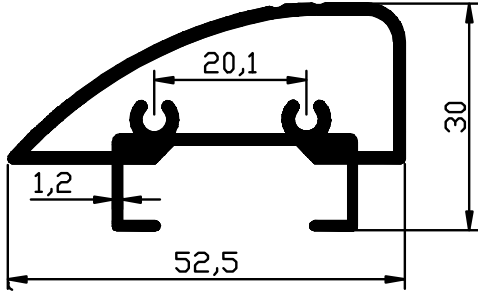

1495 - 0,734 Kg/m

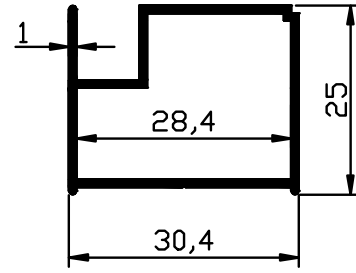

1497 - 0,314 Kg/m

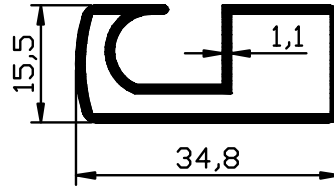

1699 - 0,356 Kg/m

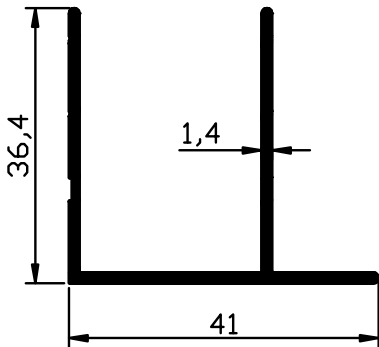

1489 - 0,418 Kg/m

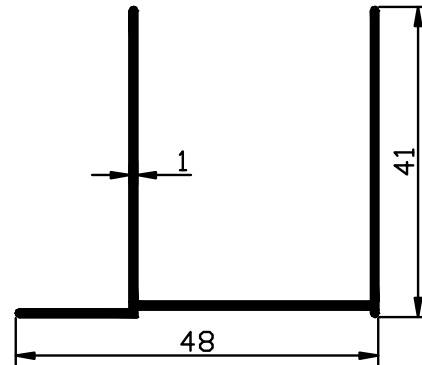

1496 - 0,345 Kg/m

DUŞAKABİN BELLA

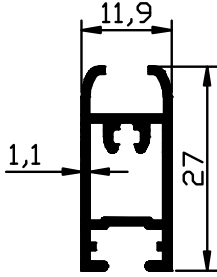

1295 - 0,279 Kg/m

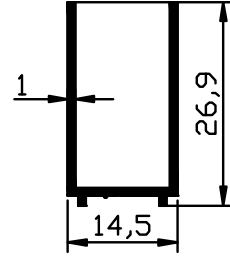

1294 - 0,179 Kg/m

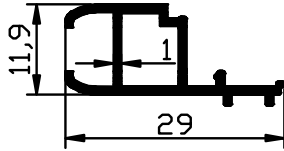

1293 - 0,203 Kg/m

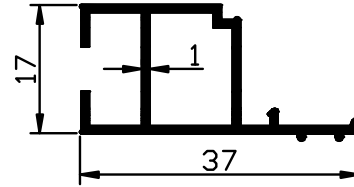

1804 - 0,276 Kg/m

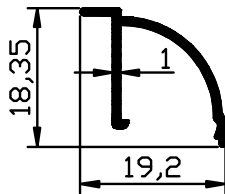

1803 - 0,122 Kg/m

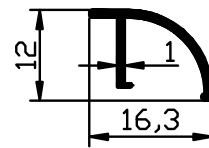

1291 - 0,089 Kg/m

DUŞAKABİN YENİ FLORA SERİSİ

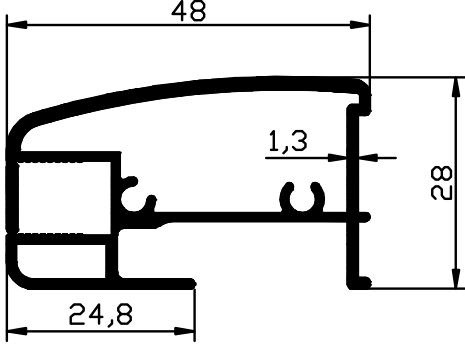

1563 - 0,716 Kg/m

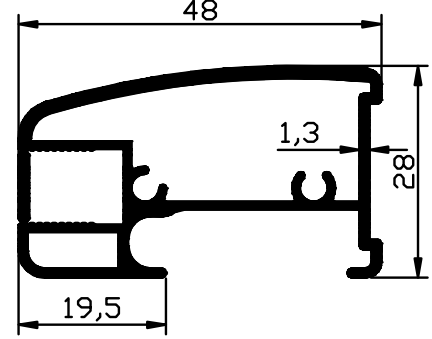

1550 - 0,710 Kg/m

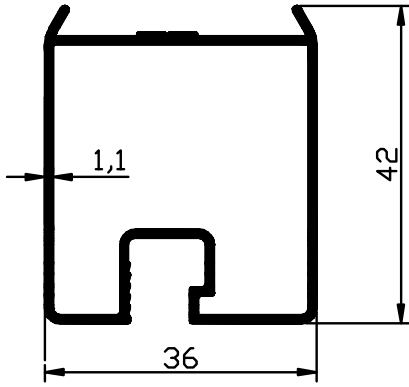

1552 - 0,537 Kg/m

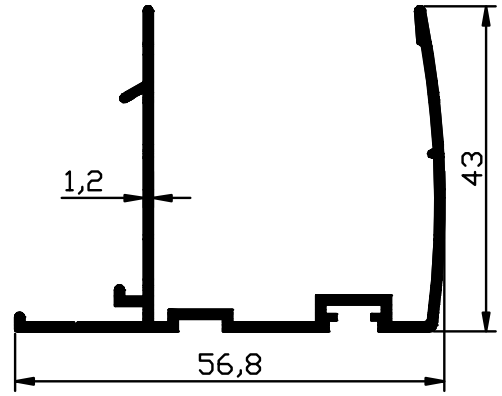

1553 - 0,532 Kg/m

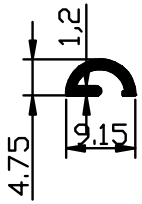

1868 - 0,052 Kg/m

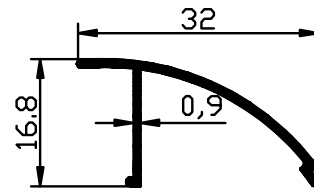

1551 - 0,146 Kg/m

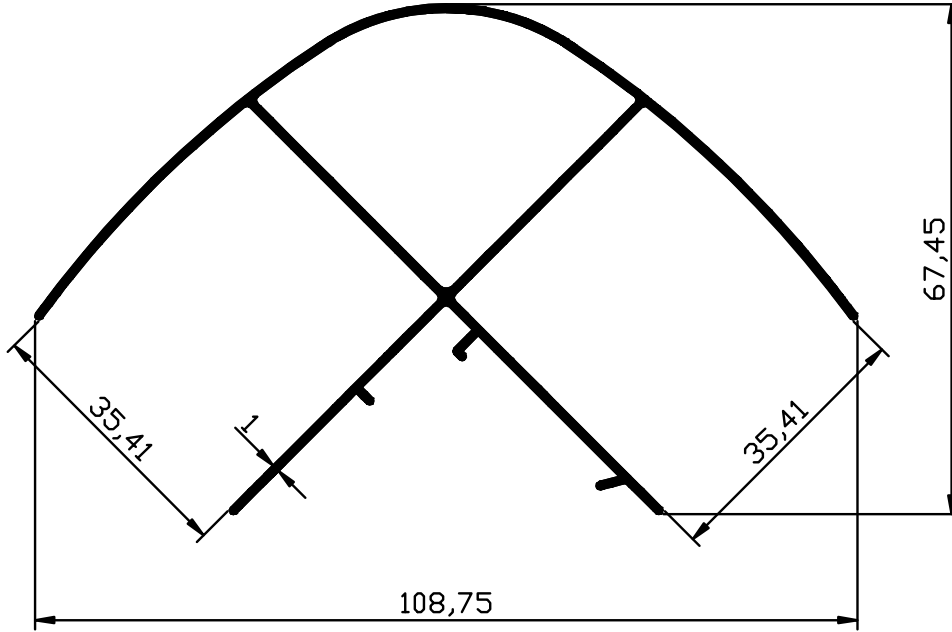

2129 - 0,823 Kg/m

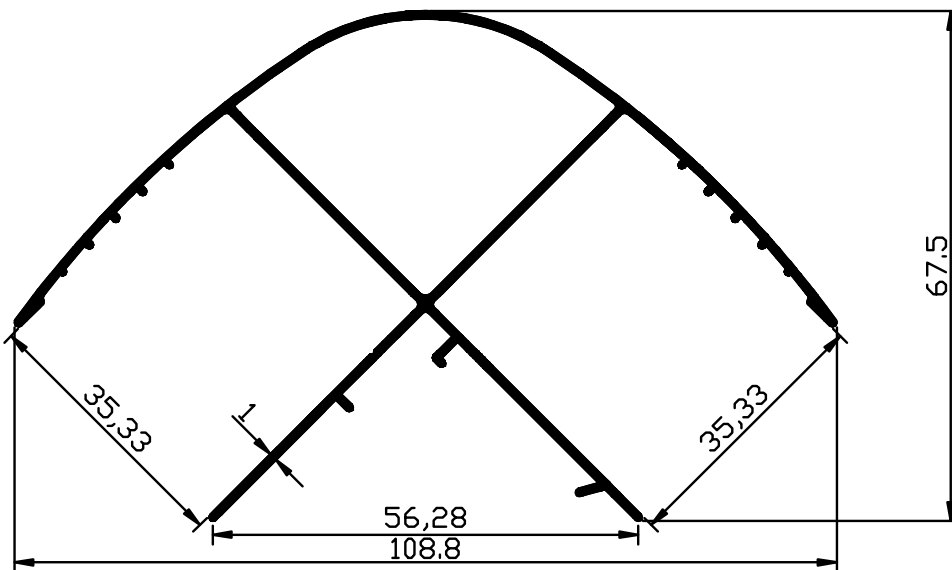

1569 - 0,850 Kg/m

DUŞAKABİN KING-EKO SİLİKONLU+FİTİLLİ

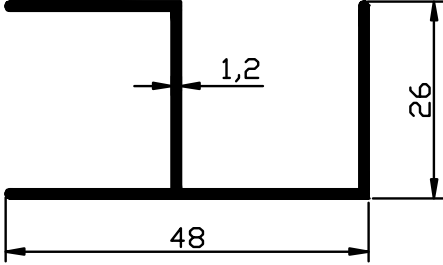

1236 - 0,388 Kg/m
600 cm - 500 cm

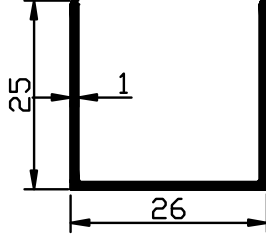

1695 - 0,200 Kg/m
600 cm - 500 cm

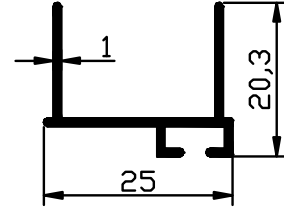

1206 - 0,184 Kg/m
660 cm - 550 cm

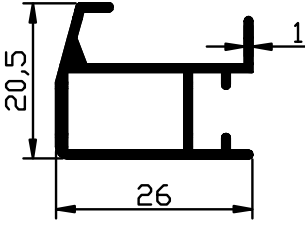

1238 - 0,286 Kg/m
600 cm

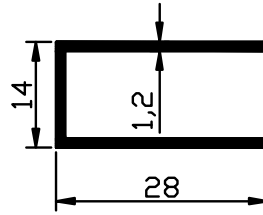

1234 - 0,219 Kg/m
600 cm - 500 cm

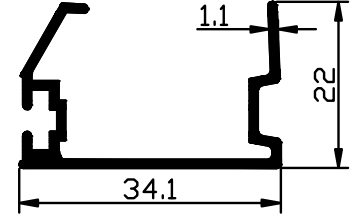

1237 - 0,294 Kg/m
660 cm - 550 cm

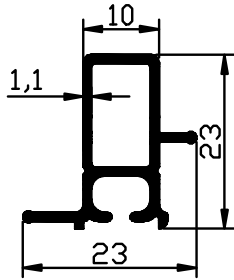

1176 - 0,243 Kg/m
530 cm - 570 cm

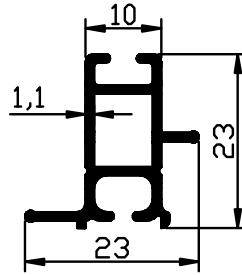

1244 - 0,257 Kg/m
530 cm - 570 cm

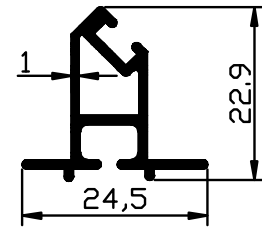

1242 - 0,242 Kg/m
530 cm - 570 cm

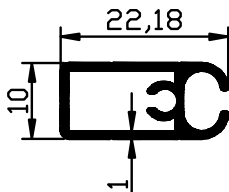

1730 - 0,197 Kg/m
530 cm - 570 cm

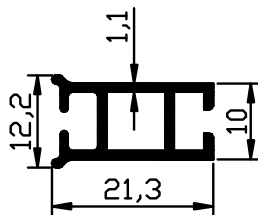

1243 - 0,206 Kg/m
530 cm - 570 cm

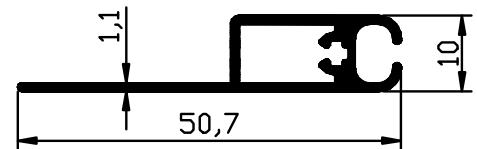

1246 - 0,305 Kg/m
600 cm

DUŞAKABİN KİNG-EKO FİTİLLİ

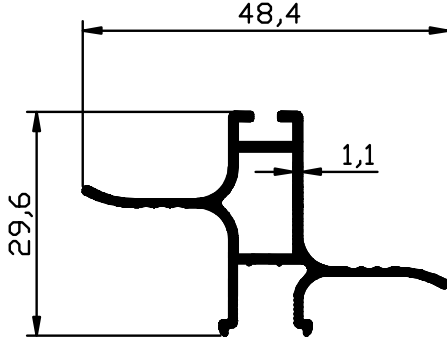

1731 - 0,355 Kg/m

530 cm - 570 cm

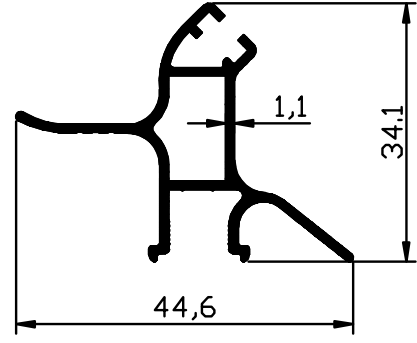

1732 - 0,365 Kg/m

530 cm - 570 cm

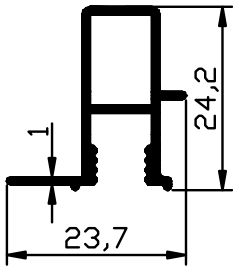

1473 - 0,235 Kg/m

530 cm - 570 cm

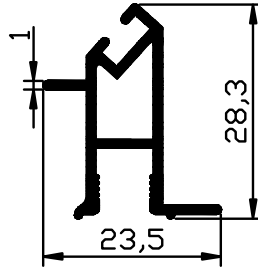

1698 - 0,278 Kg/m

530 cm - 570 cm

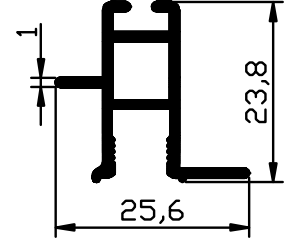

1697 - 0,273 Kg/m

530 cm - 570 cm

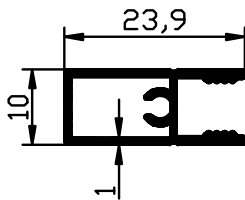

1729 - 0,226 Kg/m

530 cm - 570 cm

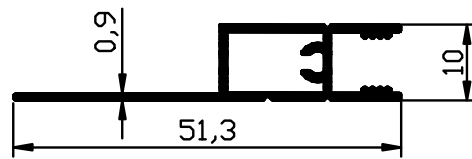

1472 - 0,273 Kg/m

600 cm

DUŞAKABİN BELLA

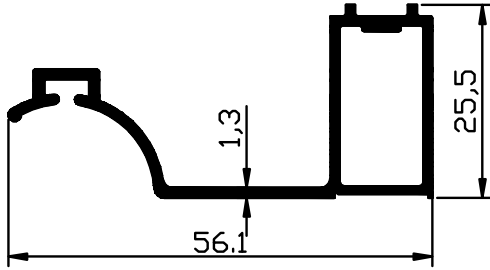
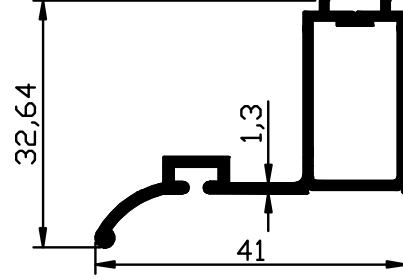
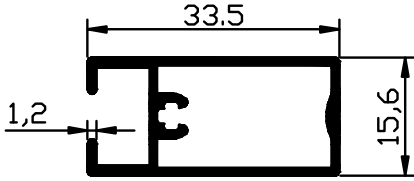
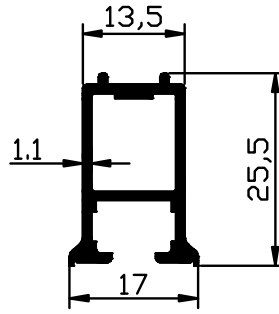
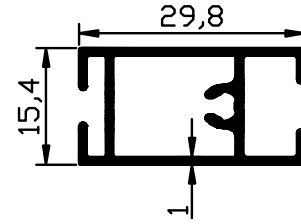
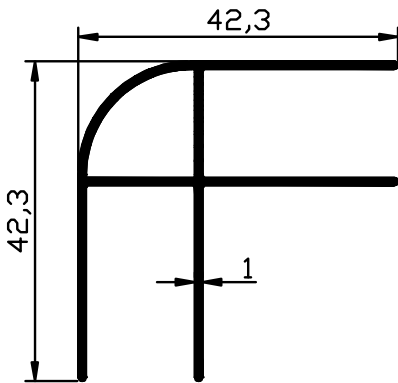
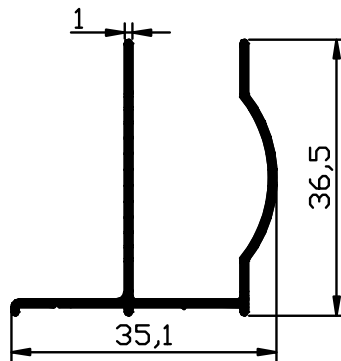
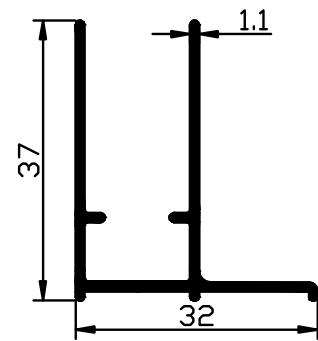
**1285 - 0,454 Kg/m****550 cm - 600 cm****1281 - 0,378 Kg/m****550 cm - 600 cm****1290 - 0,324 Kg/m****600 cm****1286 - 0,276 Kg/m****550 cm - 600 cm****1223 - 0,304 Kg/m****600 cm****1226 - 0,428 Kg/m****550 cm - 600 cm****1218 - 0,284 Kg/m****550 cm - 600 cm****1289 - 0,348 Kg/m****550 cm - 600 cm**

DUŞAKABİN BELLA

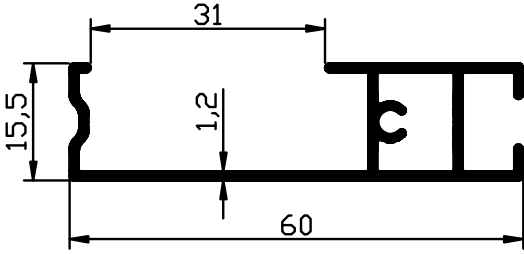
**1221 - 0,463 Kg/m**

600 cm

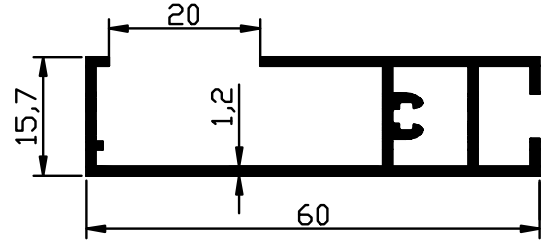
**1287 - 0,508 Kg/m**

600 cm

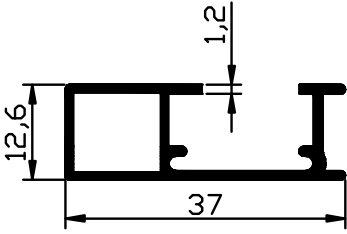
**1376 - 0,296 Kg/m**

600 cm

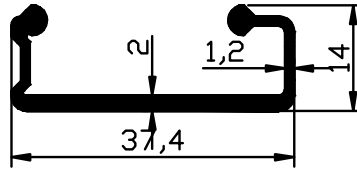
**1220 - 0,335 Kg/m**

600 cm

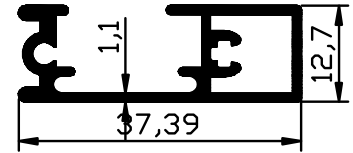
**1292 - 0,359 Kg/m**

600 cm

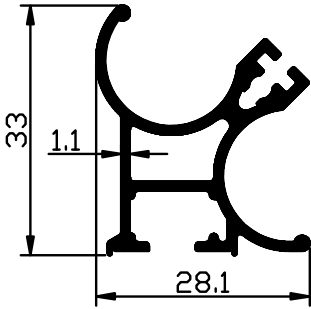
**1282 - 0,540 Kg/m**

540 cm - 580 cm

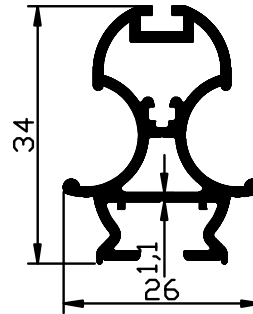
**1288 - 0,448 Kg/m**

540 cm - 580 cm

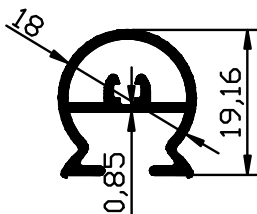
**1283 - 0,243 Kg/m**

520 cm - 560 cm

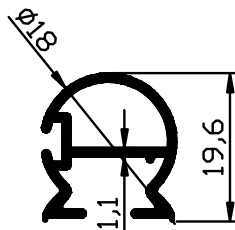
**1284 - 0,240 Kg/m**

540 cm - 580 cm

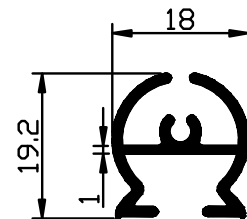
**1225 - 0,255 Kg/m**

540 cm - 580 cm