

1475 - 0.768 Kg/m

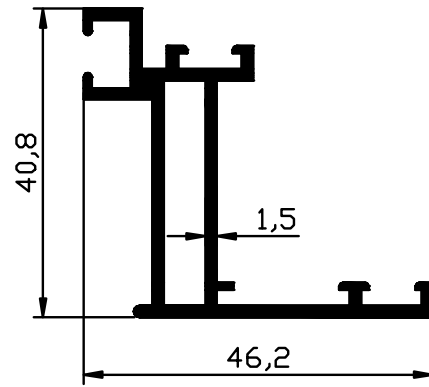

1477 - 0.653 Kg/m

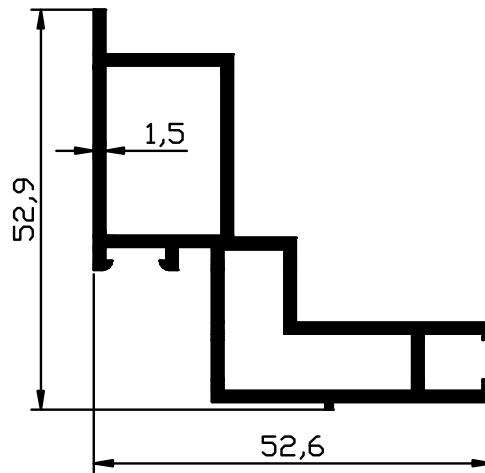

1476 - 0.838 Kg/m

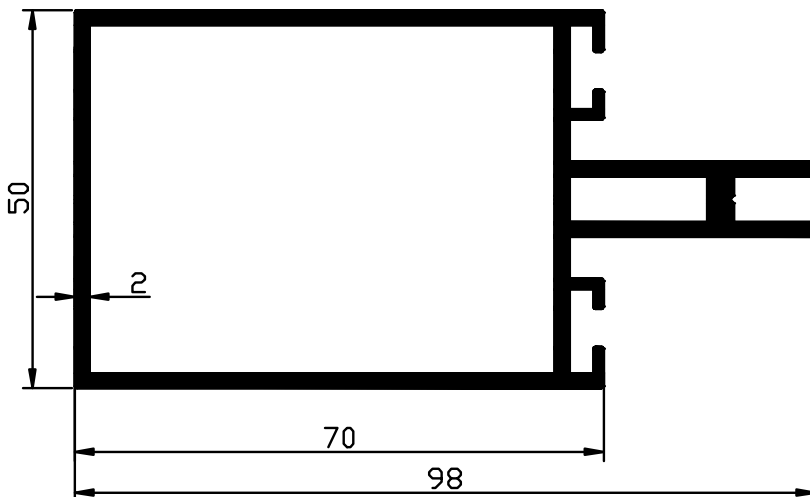

1382 - 1.745 Kg/m

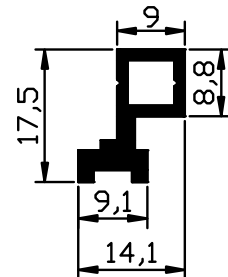

1952 - 0.230 Kg/m