

**1918 - 1.396 Kg/m**

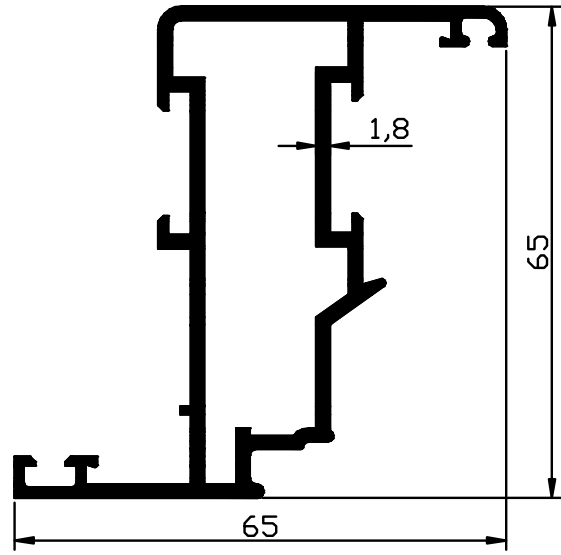

**1919 - 1.239 Kg/m**

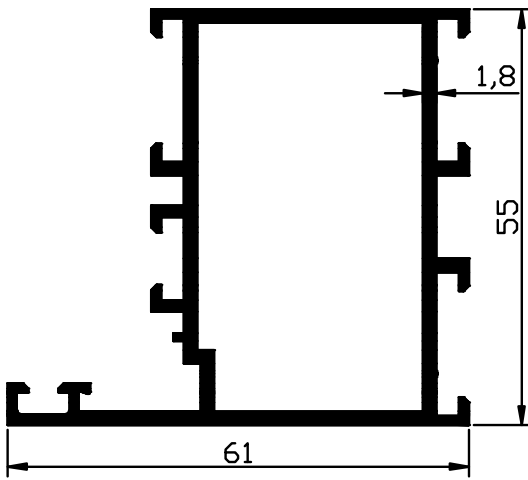

**1920 - 1.118 Kg/m**

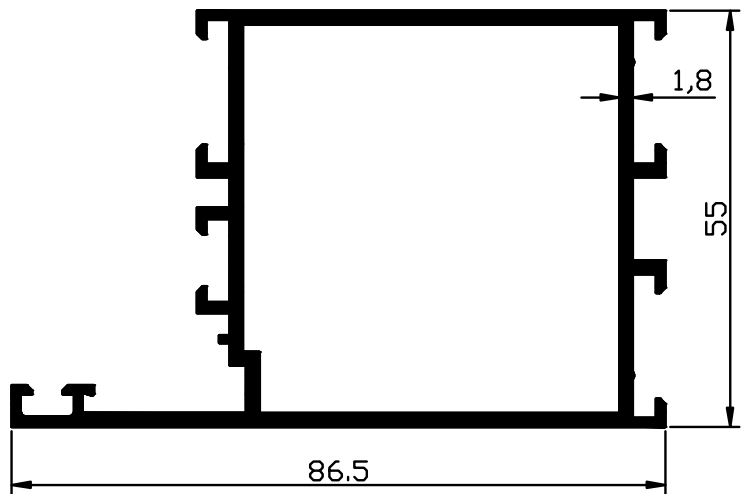

**1921 - 1.410 Kg/m**

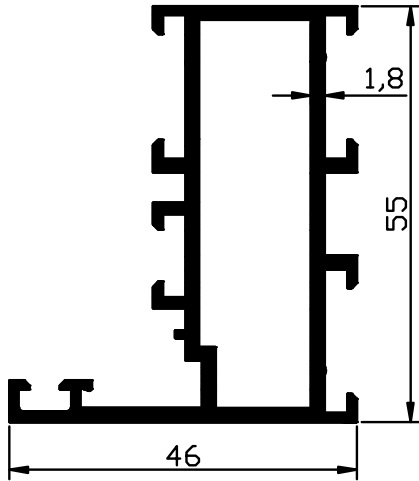

**1922 - 1.042 Kg/m**

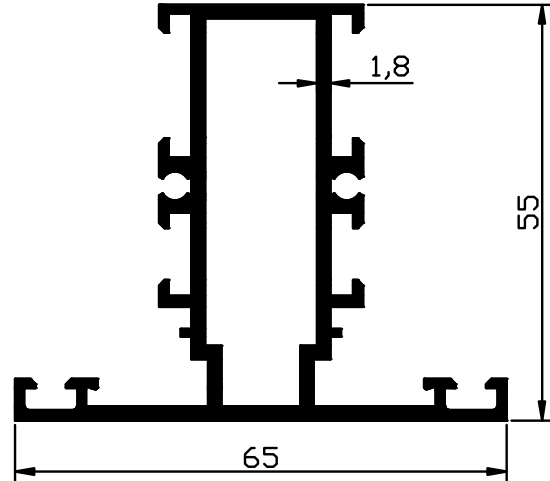

**1923 - 1.218 Kg/m**

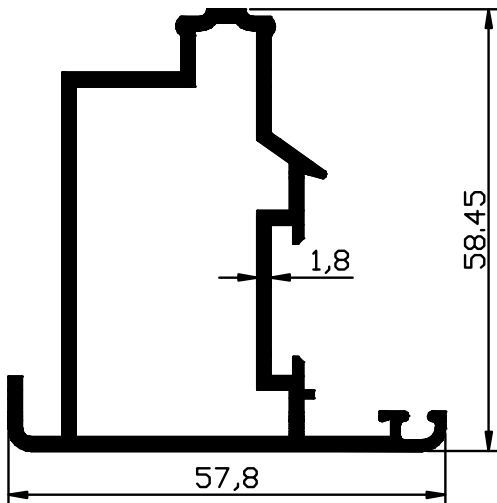

**1924 - 1.096 Kg/m**

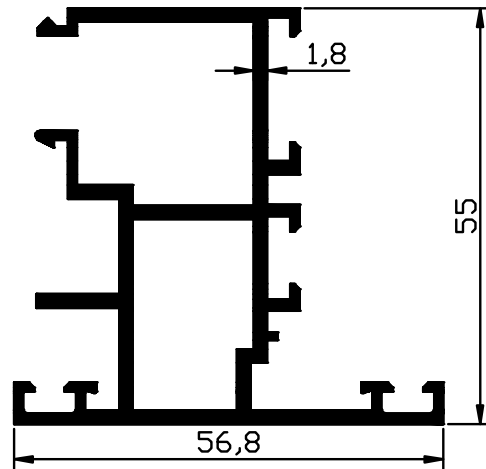

**1925 - 1.215 Kg/m**

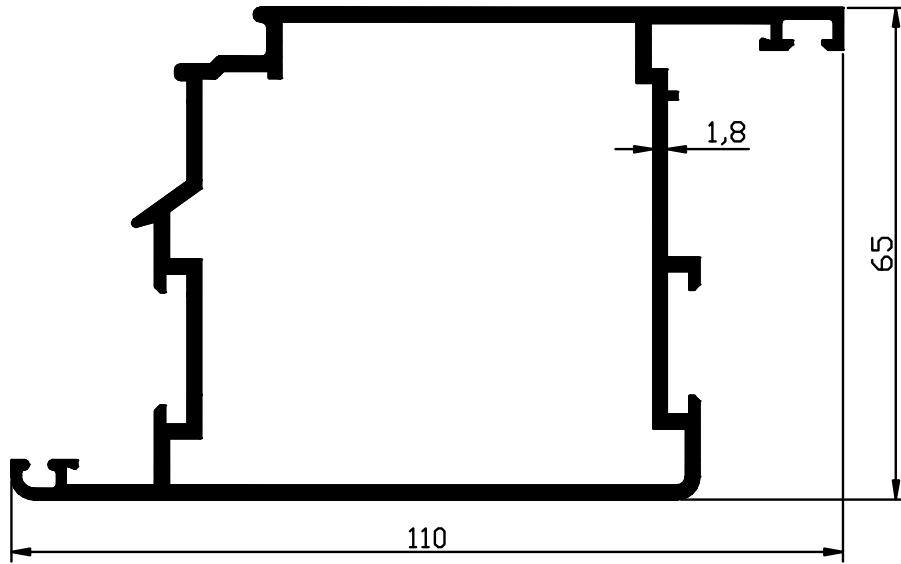

**1926 - 1.698 Kg/m**

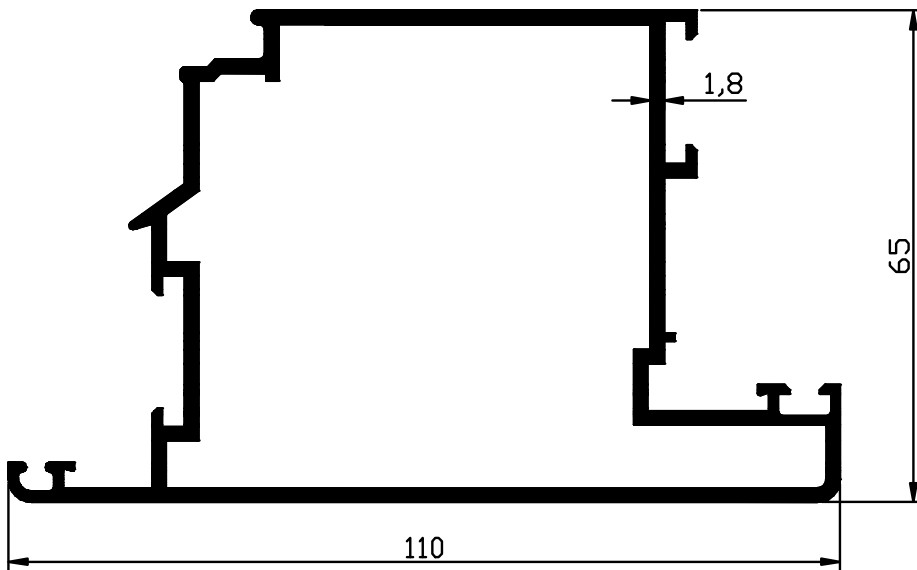

**1927 - 1.775 Kg/m**

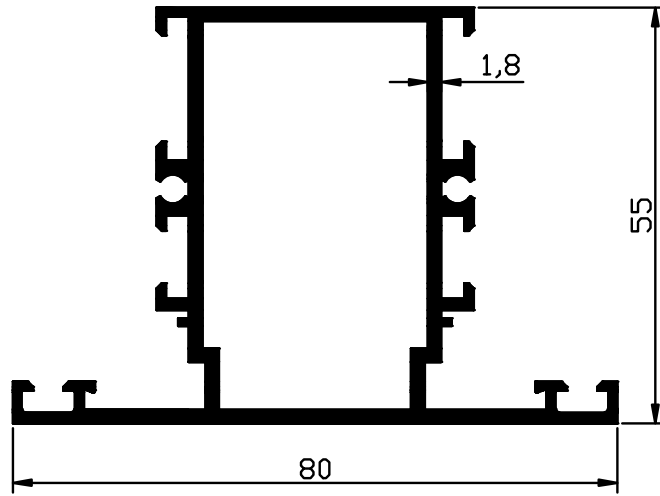

**1928 - 1.364 Kg/m**

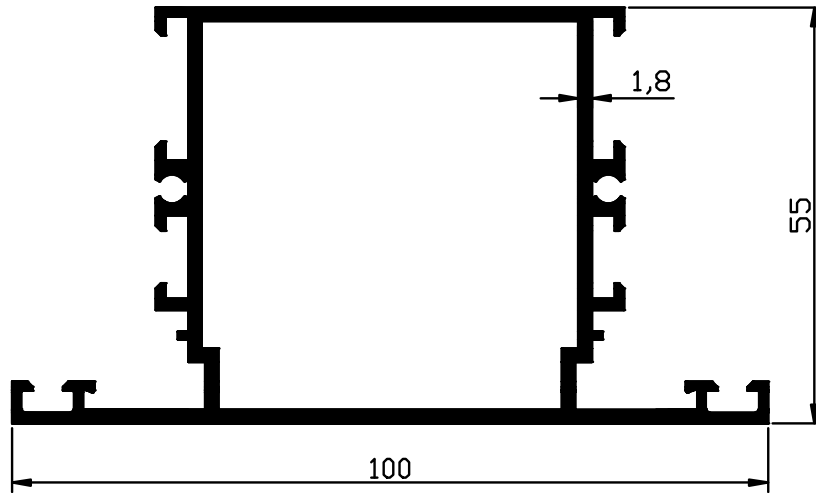

**1929 - 1.559 Kg/m**

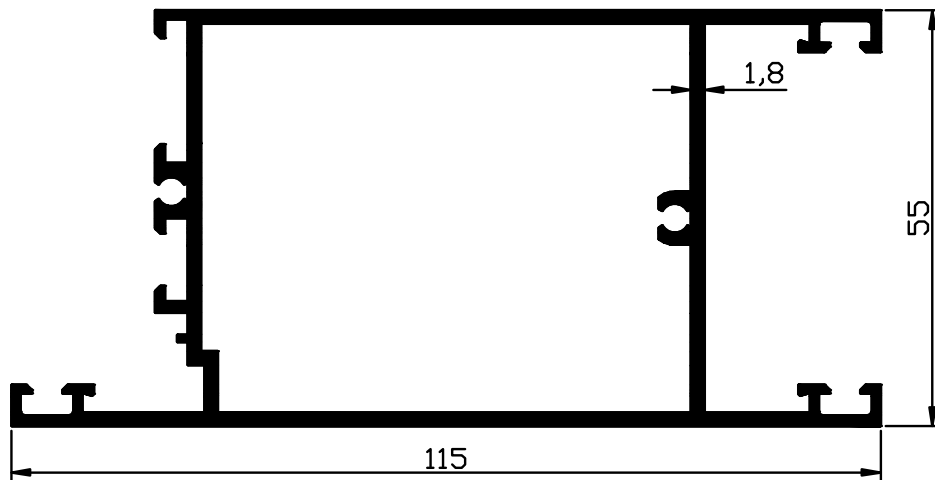

**1930 - 1.769 Kg/m**

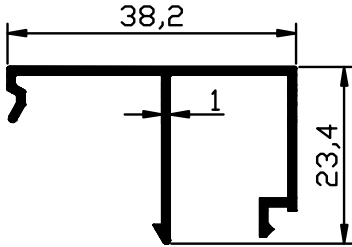

**1931 - 0.259 Kg/m**

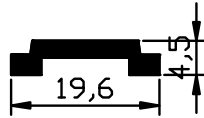

**1932 - 0.141 Kg/m**

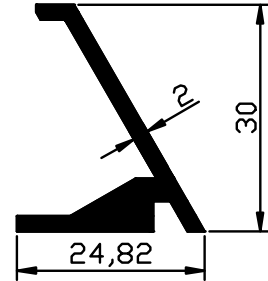

**1933 - 0.404 Kg/m**

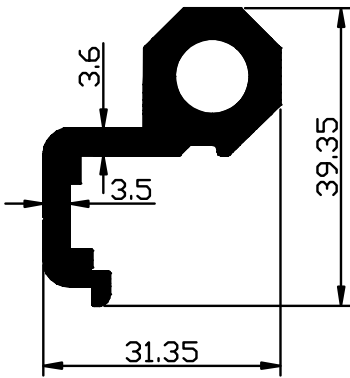

**1934 - 0.948 Kg/m**

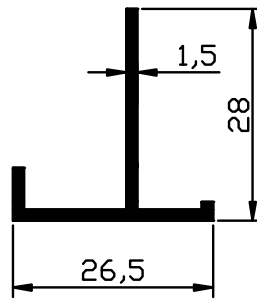

**1935 - 0.242 Kg/m**

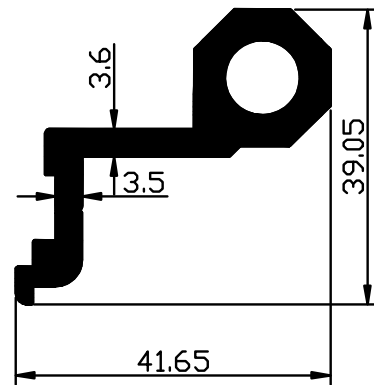

**1936 - 1.012 Kg/m**

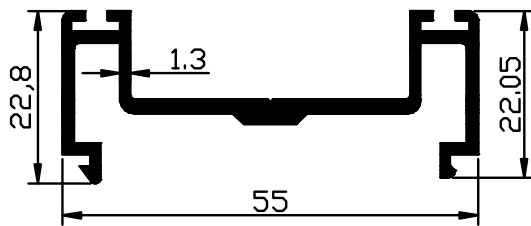

**1937 - 0.583 Kg/m**

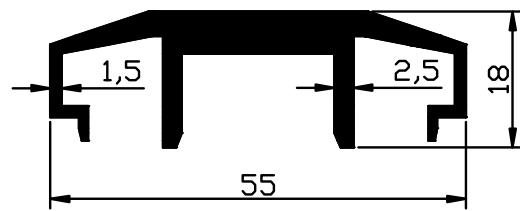

**1938 - 0.863 Kg/m**